

WS4
Balsa Andino 3 mm

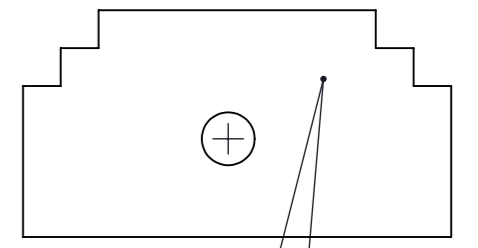

WF1
CTP 3 mm

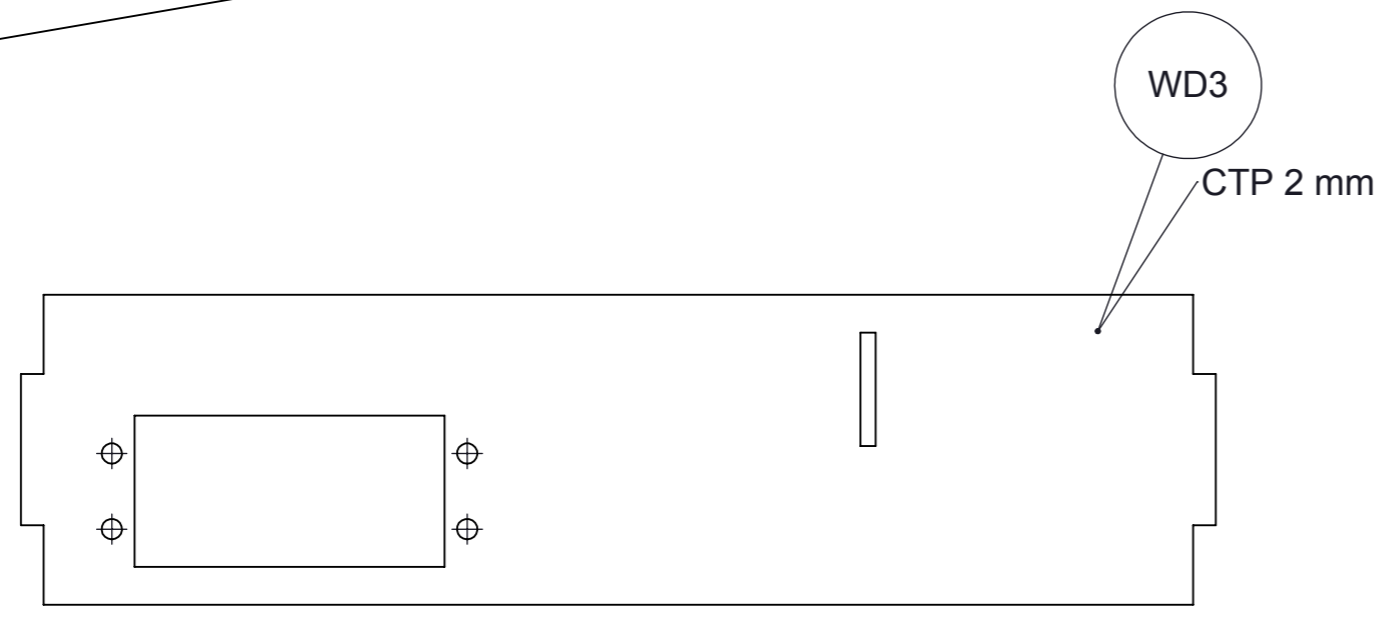

WD3
CTP 2 mm

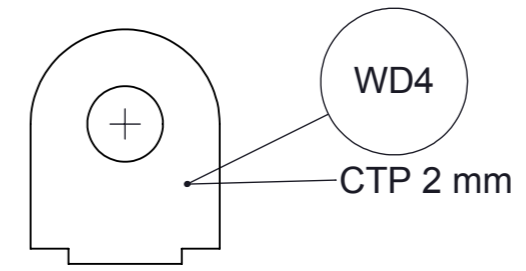

WD4
CTP 2 mm

Circuit imprimé époxy (épr 1,5)

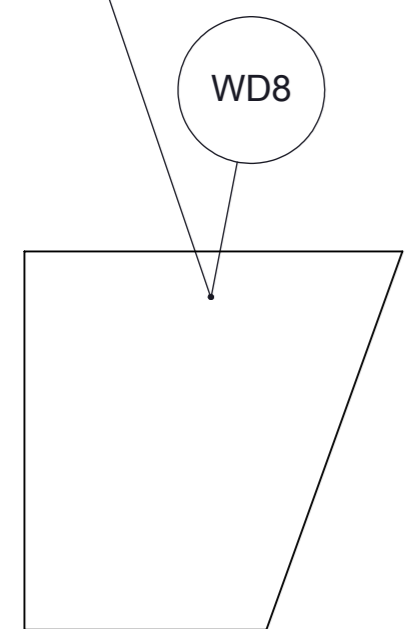

WD8

Circuit imprimé époxy (épr 1,5)

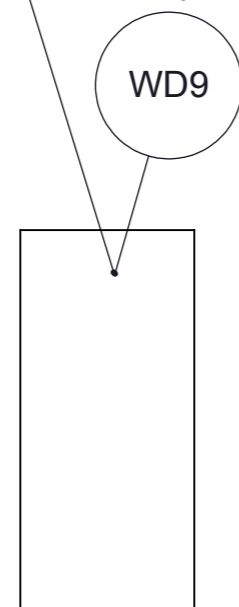

WD9

Circuit imprimé époxy (épr 1,5)

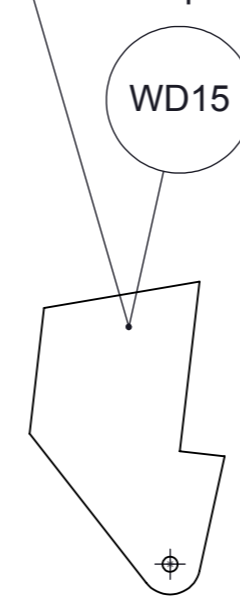

WD15

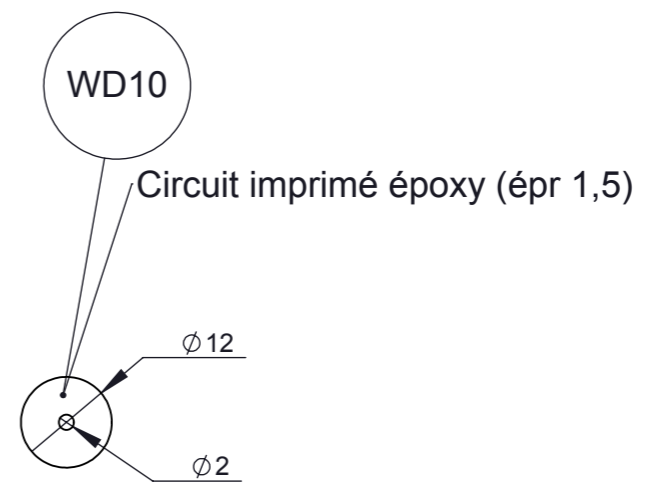

WD10
Circuit imprimé époxy (épr 1,5)

Ø12

Ø2

Support servo de volets

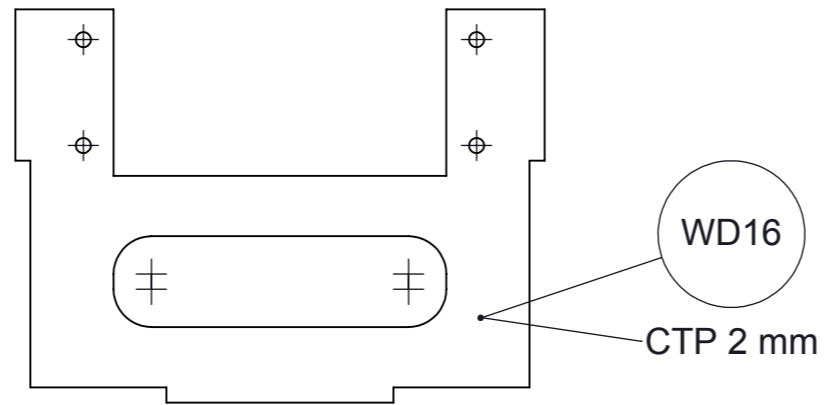
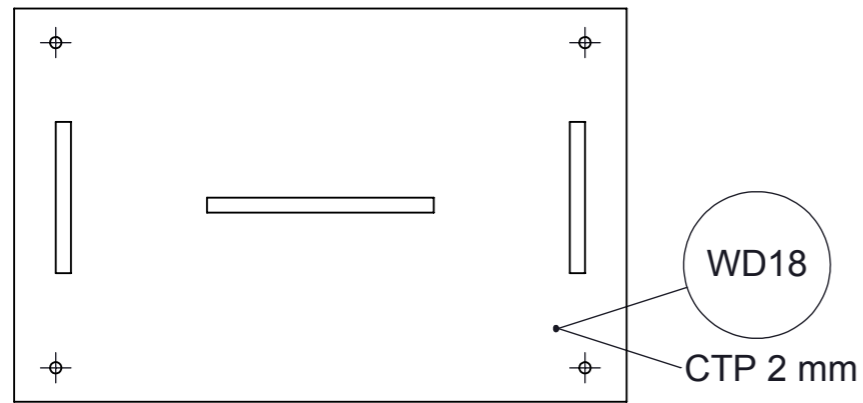
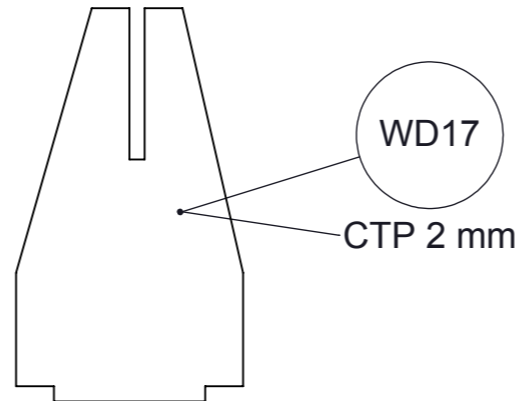
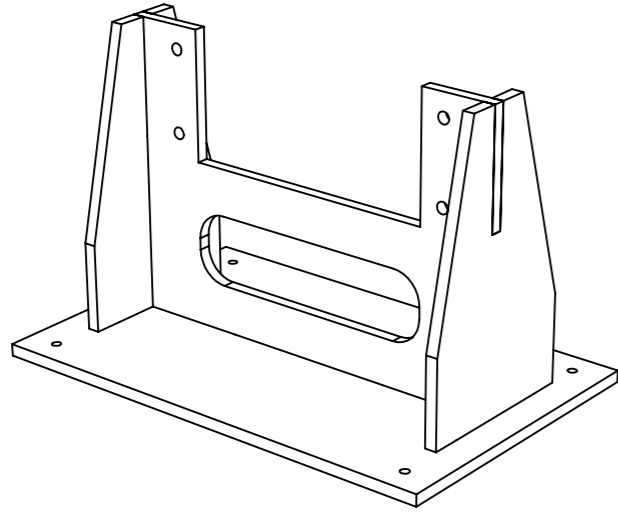

Support servo d'aileron

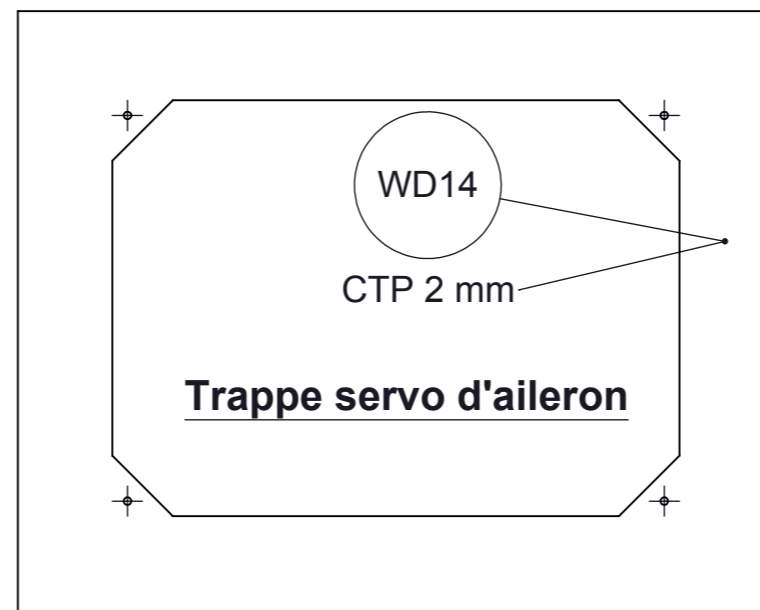
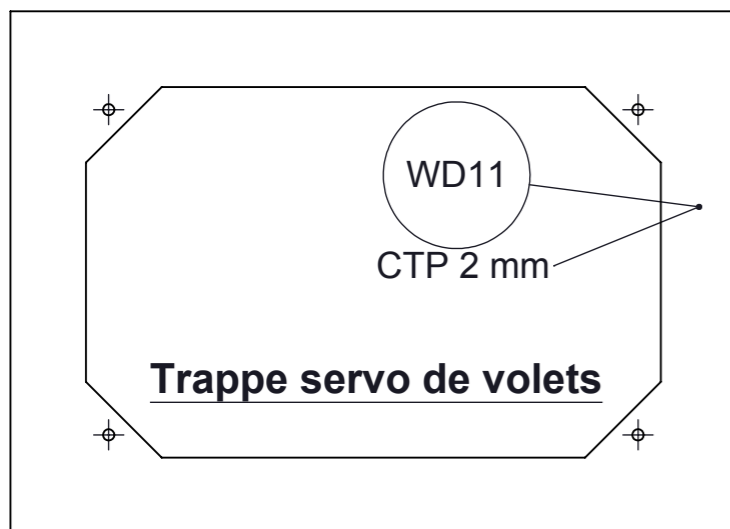
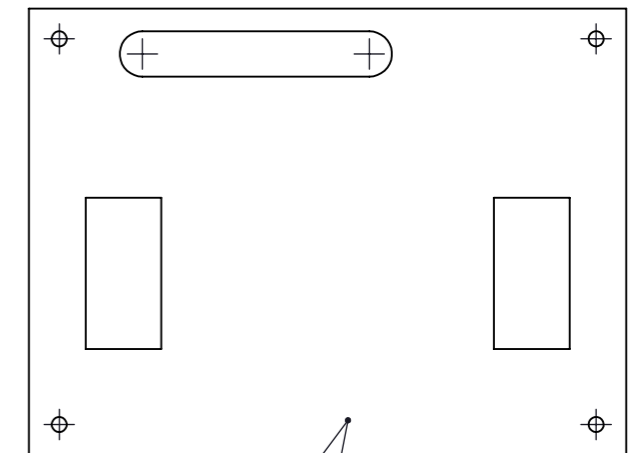
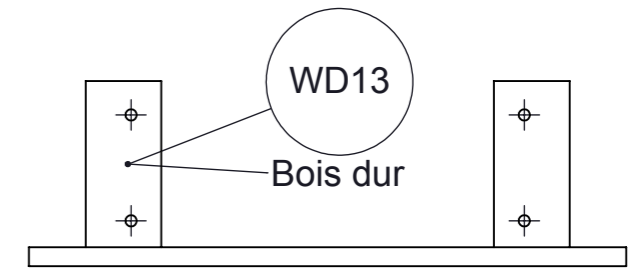
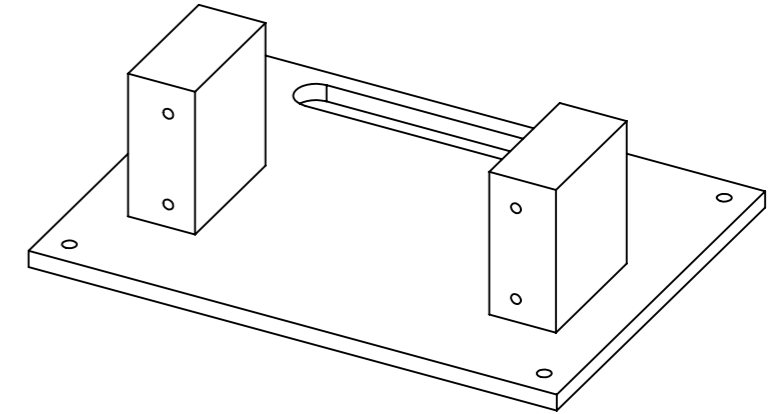

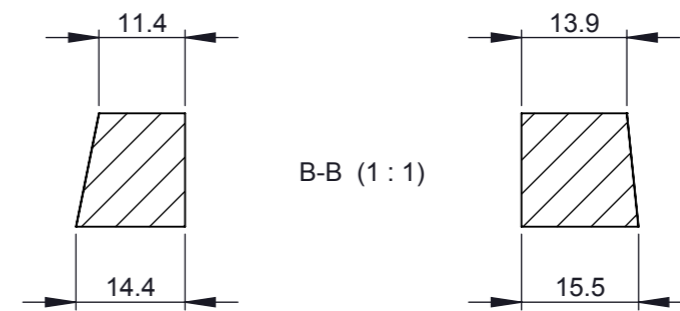
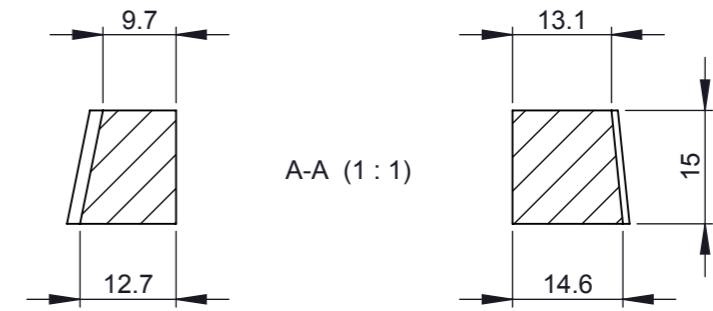
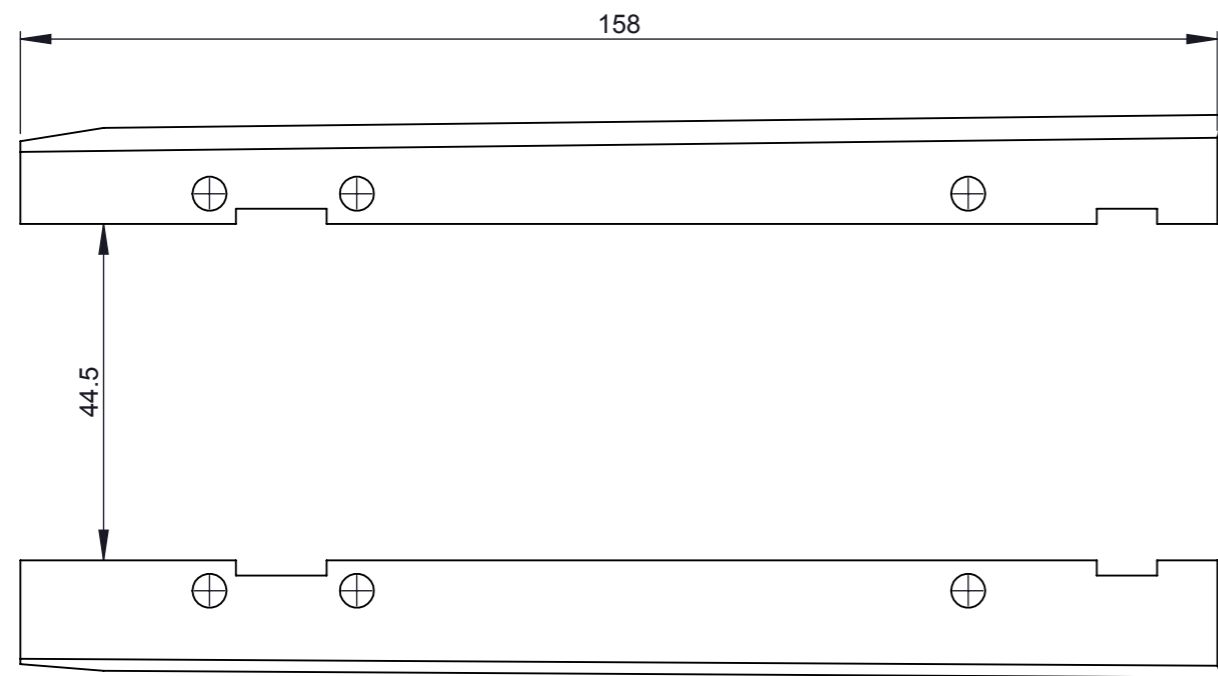
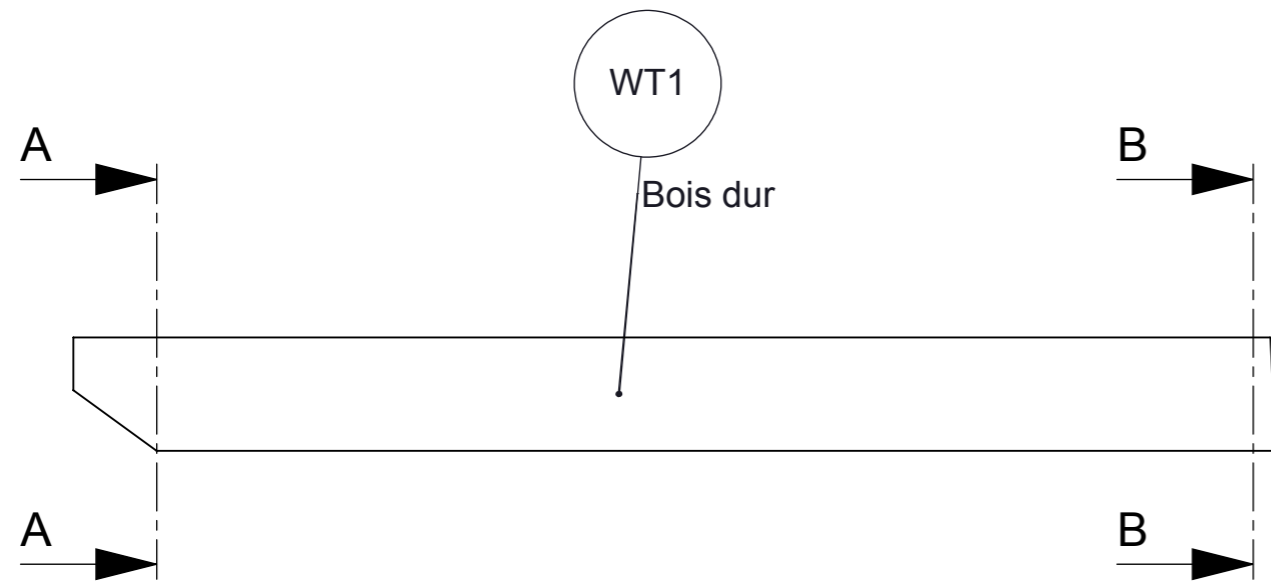

Support train d'atterrissage